

L2模块

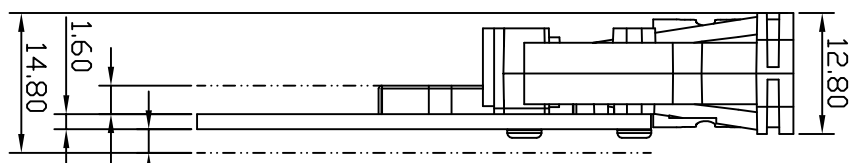

2.50(板上元件高度)
3.00(板上元件高度)

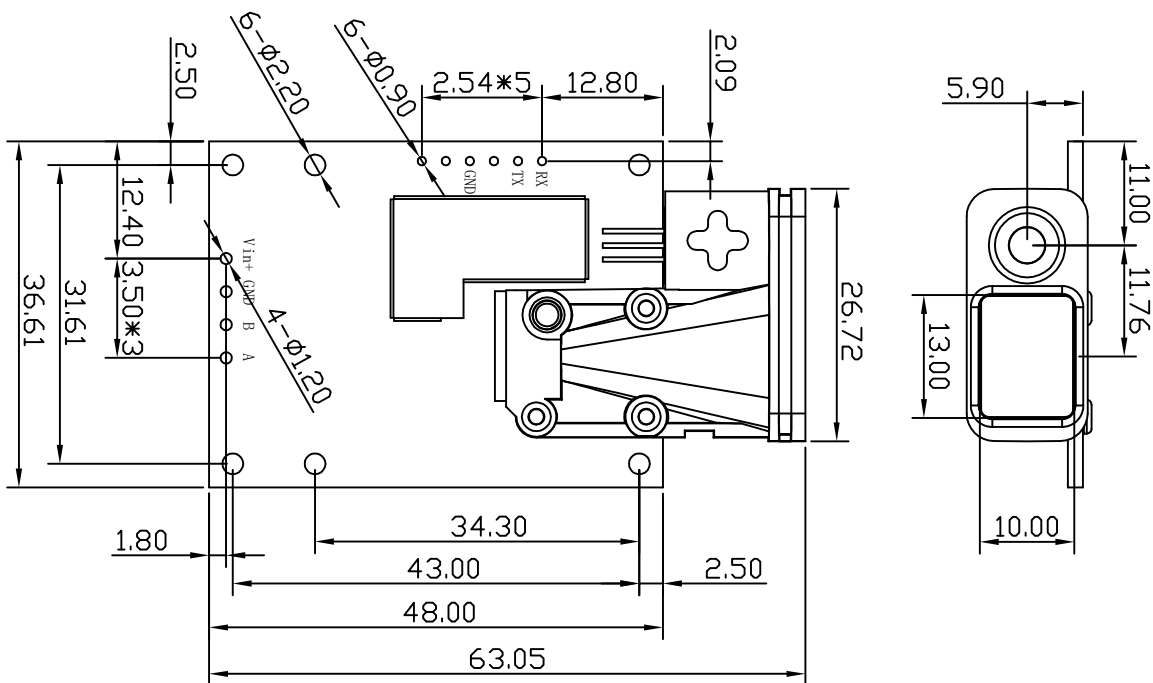